

Heat Activated Cooling Fan Controller

Heat activated cooling fan controller is a simple project which operates a brushless fan when the temperature in a particular area goes above a set point, when temperature return normal, fan automatically turns off. The project is built using LM358 Op-amp and LM35 temperature Sensor. Project required 12V DC supply and can drive 12V Fan. This project is useful in application like Heat sink temperature controller, PC, heat sensitive equipment, Power supply, Audio Amplifiers, Battery chargers, Oven.

The SMD SO8 LM35 used as temperature sensor, LM358 act as comparator provides high output when temperature rise above set point, high output drive the Fan trough driver transistor. The LM35 series are precision integrated-circuit temperature devices with an output voltage linearly-proportional to the Centigrade temperature. The LM35 device has an advantage over linear temperature sensors calibrated in Kelvin, as the user is not required to subtract a large constant voltage from the output to obtain convenient Centigrade scaling. The LM35 device does not require any external calibration or trimming to provide typical accuracies of $\pm 1/4^{\circ}\text{C}$ at room temperature. Temperature sensing range 2 to 150 centigrade. LM35 provides output of 10mV/Centigrade.

- Supply 12V DC 1Amps
- Fan 12V DC , 500mA
- Range : 2 °C to 150 °C
- Open Collector Output
- It can drive PC fan
- Onboard preset to set the Fan trigger level
- Onboard Power LED
- Onboard Output LED
- Output Driver Transistor
- Header Connector for Supply and Fan
- PCB dimensions 59.85 mm x 12.70 mm

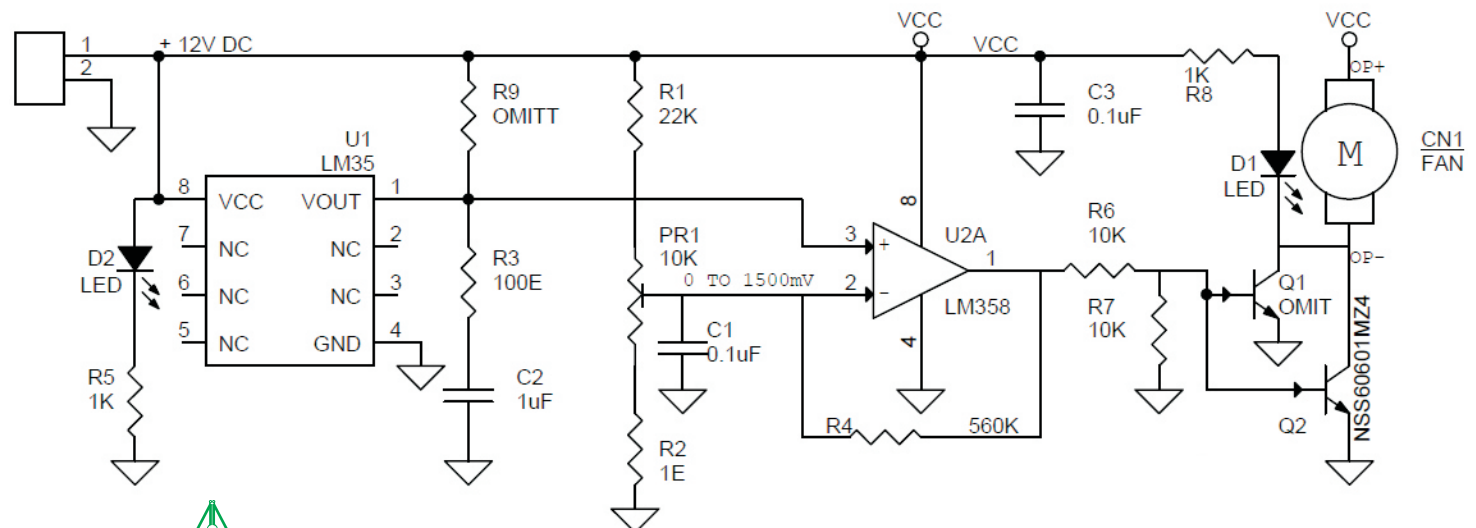
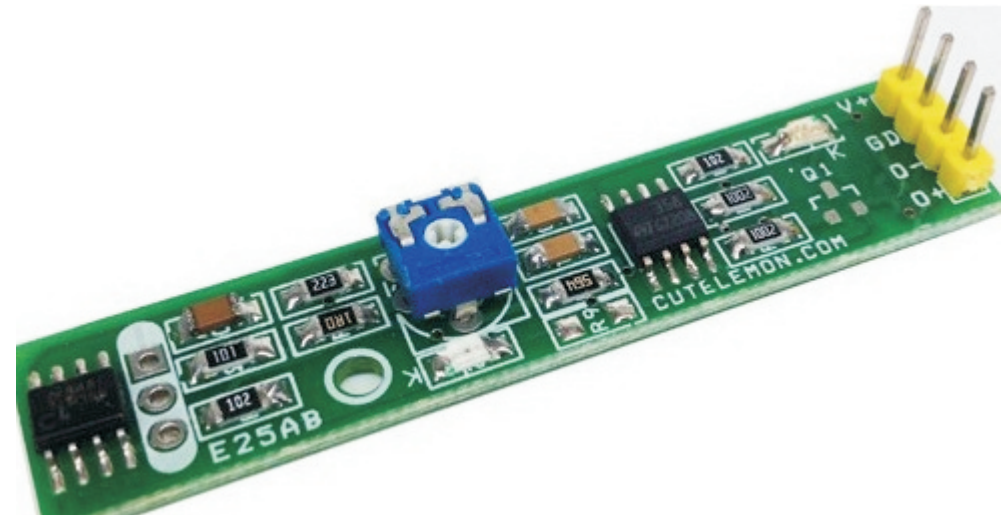

Heat Activated Cooling Fan Controller

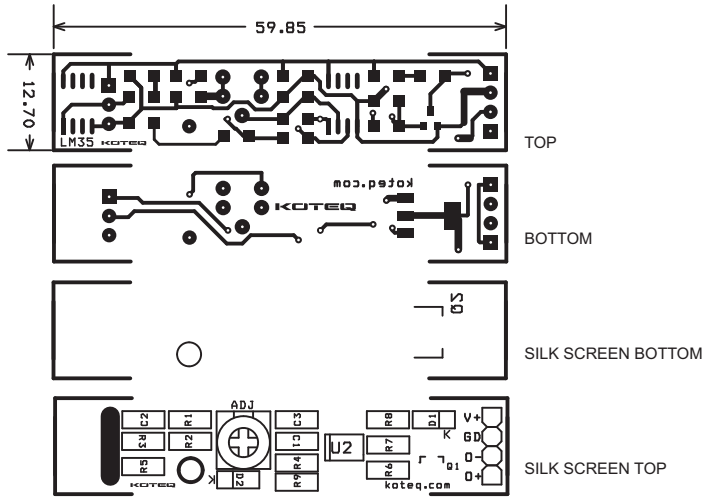

BOM			
SR.	QNTY.	REF	DESC.
1	2	CN1,+ 12V DC	2 PIN HEADER CONNECTOR
2	2	C1,C3	0.1uF SMD1206
3	1	C2	1uF SMD 1206
4	2	D1,D2	LED SMD 1206
5	2	R6,R7	10K
6	1	Q1	OMIT
7	1	Q2	NSS60601MZ4
8	1	R1	22K SMD 1206
9	1	R2	1E SMD 1206
10	1	R3	100E SMD 1206
11	1	R4	560K SMD 1206
12	2	R5,R8	1K SMD 1206
13	1	R9	OMITT
14	1	U1	LM35 SMD SO8
15	1	U2	LM393 SMD SO8
16	1	PR1	10K SMALL

